CAN 565 Series

Softener Manual

Note:

1. Read all instructions carefully before operation.
2. Avoid pinched o-rings during installation by applying (provided with install kit) NSF certified lubricant to all seals.
3. Unit is factory set for "Clean Water" application. See factory settings for "Problem Water" on page 10.
4. This system is not intended for treating water that is microbiologically unsafe or of unknown quality without adequate disinfection before or after the system.

54575

Rev 0, May 4, 2015

TABLE OF CONTENTS

System Specifications.....	3
How Your Water Conditioner Works.....	3
Main Valve Functions.....	4
General Installation.....	5
Start-up Instructions.....	6
Level I User Programming.....	6
Level II User Programming.....	8
System Configuration.....	10
Maintenance.....	11
Valve Drive Assembly Exploded View.....	14
Control Valve Assembly Exploded View.....	15
Troubleshooting.....	16
Guarantee.....	17

Efficiency Statement

This product is efficiency rated according to NSF/ANSI 44. The stated efficiencies are valid only at the specified salt dosages and maximum service flow rate.

Product Data Sheet							
Model Number	565-75C	565-100C	565-75	565-100	565-150	565-200	565-300
Qty High Capacity Resin	0.75 ft ³	1.0 ft ³	0.75 ft ³	1.0 ft ³	1.5 ft ³	2.0 ft ³	3.0 ft ³
Rated Service Flow (gpm)	7.5	12.1	7.5	11.0	11.2	12.4	12.9
Pressure Drop at Rated Service Flow (psi)	7.0	15.0	9.0	15.0	15.0	15.0	15.0
Rated Softening Capacity (grains)	9,609 @ 2.25lbs	13,269 @ 3lbs	10,222 @ 3lbs	13,269 @ 3lbs	20,443 @ 4.5lbs	27,258 @ 6lbs	40,887 @ 9lbs
Efficiency (grains/lb salt)	4,271	4,543	4,543	4,543	4,543	4,543	4,543
Max. Flow Rate to Drain (gpm)	2.0	2.4	1.5	2.0	2.4	3.5	5.0
Working Pressure	Min. 20 - Max. 125 psi						
Operating Temperature	Min 39 - Max. 100 degrees Fahrenheit						

These softeners conform to NSF/ANSI 44 for the specific performance claims as verified and substantiated by test data. These models are efficiency rated. The efficiency rating is valid only at the stated salt dose and maximum service flow rate. They have a demand initiated regeneration (D.I.R.) feature that complies with specific performance specifications intended to minimize the amount of regenerant brine and water used in their operation. These softeners have a rated softener efficiency of not less than 3350 grains of total hardness exchange per pound of salt (based on sodium chloride) and shall not deliver more salt than their listed ratings. The rated salt efficiency is measured by laboratory tests described in NSF/ANSI Standard 44. These tests represent the maximum possible efficiency that the systems can achieve. Operational efficiency is the actual efficiency after the system has been installed. It is typically less than the efficiency due to individual application factors including water hardness, water usage, and other contaminants that reduce the softener's capacity. These systems are not intended for use with water that is microbiologically unsafe or of unknown quality without adequate disinfection before or after the system. For best results, use plain, white block salt. Refer to Installation/operation manual and warranty for further details on installation, parts and service, maintenance and further restrictions or limitations to the use of the product.



WQA Tested and Certified according to NSF/ANSI 44 for effective reduction of hardness (calcium and magnesium) as verified and substantiated by test data.

Tested and Certified by the Water Quality Association to CSA B483.1.

System Specifications

Model	System Capacity Grains			Flow Rate		Regeneration Water		Mineral Tank Size	Resin Cu. Ft.	Brine Tank / Cabinet Size Inches	Salt Capacity (Lbs)	Ship Weight (Lbs)
	@ 10 lbs/cu ft	@ 6 lbs/cu ft (Factory Setting)	@ 3 lbs/cu ft	Service USGPM	Backwash USGPM	Clean Water (Factory Setting)	Problem Water					
565-75	21,000	18,750	11,550	8.0	1.5	29.5	37.0	8 x 44	0.75	15.0 x 15.0 x 34.7	230	105
565-100	28,000	25,000	15,400	10.0	2.0	38.0	48.0	9 x 48	1.00	15.0 x 15.0 x 34.7	230	122
565-150	42,000	37,500	23,100	12.0	2.4	48.5	60.5	10 x 54	1.50	15.0 x 15.0 x 34.7	230	155
565-200	56,000	50,000	30,800	15.0	3.5	80.5	95.5	12 x 52	2.00	20.3 x 37.4	385	158
565-250	70,000	62,500	38,500	15.0	4.0	92.5	112.5	13 x 54	2.50	20.3 x 37.4	385	198
565-300	84,000	75,000	46,200	15.0	5.0	116.5	141.5	14 x 65	3.00	23.0 x 40.5	550	244
565-75C	21,000	18,750	11,550	8.0	2.0	29.5	37.0	9 x 35	0.75	13.8 x 23.6 x 43.3	225	93
565-100C	28,000	25,000	15,400	10.0	2.4	38.0	48.0	10 x 35	1.00	13.8 x 23.6 x 43.3	225	110

Figure 1. Specifications

- C indicates cabinet Models
- Water Temperature = Min 39°F / Max 110°F
- Operating Pressure = Min 20 PSI / Max 125 PSI
- Voltage = 110 volts standard
- Units contain 8% Super Capacity Ion Exchange Resin
- At the stated service flow rates, the pressure drop through these devices will not exceed 15 psig.
- Units are factory set for "Clean Water" applications. For installations with problem water (Iron, Manganese, turbidity, etc.) please refer to Figure 12 on page 10 for "Problem Water" valve settings.
- The manufacturer reserves the right to make product improvements which may deviate from the specifications and descriptions stated herein, without obligation to change previously manufactured products or to note the change.
- The above capacity and flow rate specifications have not been validated by WQA.

How Your Water Conditioner Works

The principle behind water softening is simple chemistry. A water softener contains resin beads which hold electrically charged ions. When hard water passes through the softener, calcium and magnesium ions are attracted to the charged resin beads. It's the resulting removal of calcium and magnesium ions that produces soft water.

This valve is controlled with simple, user-friendly electronics displayed on a large LCD screen. The main page displays the current date and time. In addition, the main page also shows key valve information and statistics including; current capacity setting, volume remaining, date of last regeneration, current flow rate, and peak flow rate.

MAY 8, 2009 9:05 AM	CAPACITY 1,350 GAL	VOLUME REMAINING 1,125 GAL
REGEN DAYS 7 DAYS	REMAINING DAYS 5 DAYS	REGENERATION TIME 2:00 AM
LAST REGEN MAY 4, 2009	CURRENT FLOW 1.5 GPM	PEAK FLOW 5.8 GPM

Figure 2. Main Page Displays

NOTE: REGEN DAYS and REMAINING DAYS are only shown in the CALENDAR CLOCK mode or METER OVERRIDE mode.

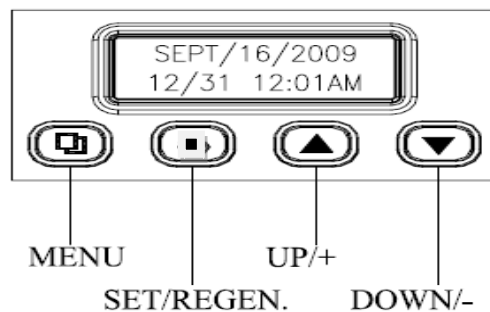

Figure 3. Key Pad Configuration

MENU BUTTON "□":

The function of this key is to enter the level one programming mode where the valve settings can be adjusted.

SET / REGEN BUTTON “□”: This button has two functions. The first is to initiate a manual regeneration by holding the button for 3 or more seconds. The second function is while in programming mode, pressing this key allows the user to change the value of each setting.

UP / DOWN “▲▼”: These buttons are used to increase or decrease the value of the settings while in the programming mode.

System Initialization

When power is first supplied, the valve may take up to two minutes to initialize the valve. During this time the valve will show “INITIALIZING WAIT PLEASE”. Do not touch any buttons at this time. When the valve reaches the service position, it will display the current date and time.



Figure 4. System Initialization Display

Main Valve Functions

Regeneration Mode: 1. METER DELAYED (FACTORY SETTING) 2. METER IMMEDIATE
 3. CALENDAR CLOCK 4. METER OVERRIDE

Capacity Calculation: 1. AUTOMATIC (FACTORY SETTING) 2. MANUAL

Adjustable Cycles: All of the valve cycles are fully adjustable.
 1. BACKWASH 2. BRINE / RINSE 3. RINSE 4. REFILL

NOTE: Refer to Level Two User Programming for description of each mode.

During a regeneration cycle, the valve will display what position it is advancing to. Once in the correct position, the valve will display the current position along with the time remaining for that cycle. On the bottom row, the time remaining is also graphically displayed.



Figure 5. Regeneration Cycle Valve Display

Manual Regeneration (Delayed or Immediate)

If screen is locked, press “□ MENU” for 3 seconds to unlock. To initiate an immediate regeneration, press the SET / REGEN button for 3 seconds, an option for delayed or immediate regeneration will appear. Press the SET / REGEN button again and delayed will begin flashing, press the down arrow button to have immediate flash, press the SET / REGEN button and then press the menu button and the valve will immediately start into manual regeneration.

To initiate a delayed regeneration, press the SET / REGEN button for 3 seconds, then press the menu button and a regeneration will be queued to the next pre-set regeneration time (2:00 a.m.).

Control Operation During A Power Failure

In the event of a power failure, the valve will keep track of the time and day for 48 hours. The programmed settings are stored in a non-volatile memory and will not be lost during a power failure. If power fails while the unit is in regeneration, the valve will finish regeneration from the point it is at once power is restored. If the valve misses a scheduled regeneration due to a power failure, it will queue a regeneration at the next regeneration time once power is restored.

General Installation

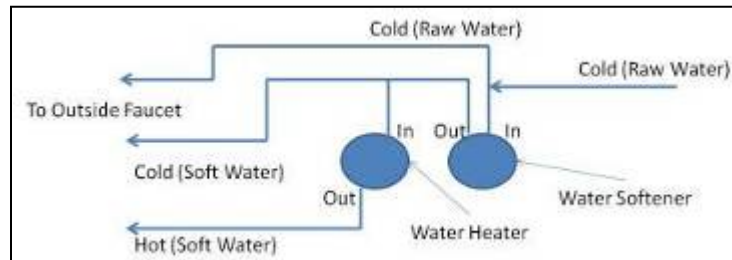
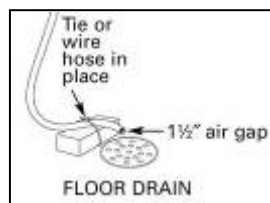

Figure 6. Piping Diagram

- 1) Locate the softener tank and brine tank close to a drain where the system will be installed. The surface should be clean and level.
- 2) Perform all plumbing according to local plumbing codes.
 - a) Use a ½" minimum pipe or tubing size for the drain line
 - b) Use a ¾" pipe or tubing for backwash flow rates that exceed 7 gpm or length that exceeds 20ft (6 m)
 - c) **ON COPPER PLUMBING SYSTEMS BE SURE TO INSTALL A GROUNDING WIRE BETWEEN THE INLET AND OUTLET PIPING TO MAINTAIN GROUNDING.**
- 3) Any solder joints near the valve must be done before connecting any piping to the valve. Always leave at least 6" (152 mm) between the valve and joints when soldering pipes that are connected to the valve. Failure to do this could cause damage to the valve.
- 4) If the valve is not installed on the tank, cut the 1" central pipe flush with top of each tank. Lubricate the large o-ring on the valve that seals against the tank. Screw the valve on to the tank. Be careful to not cross thread the valve into the tank. Only use silicone lubricant.
- 5) Connect the drain hose to the valve and secure it with a hose clamp. Run the drain hose to the nearest laundry tub or drain pipe. This can be ran up overhead or down along the floor. If running the drain line more than 20 ft overhead, it is recommended to increase the hose size to ¾". NEVER MAKE A DIRECT CONNECTION INTO A WASTE DRAIN. A PHYSICAL AIR GAP OF AT LEAST 1.5" SHOULD BE USED TO AVOID BACTERIA AND WASTEWATER TRAVELLING BACK THROUGH THE DRAIN LINE INTO THE SOFTENER.



- 6) Connect the brine line from the valve to the air check / safety elbow as per figure 7. Double check to make sure all connections are assembled correctly and the brass and plastic nuts are tight and secure to prevent leaks.
- 7) Add water until there is approximately 1" (25 mm) of water above the grid plate. If the tank does not have a grid, add water until it is above the air check in the brine tank. Do not add salt to the brine tank at this time.
- 8) Place the unit in the bypass position.
- 9) Slowly turn on the main water supply.
- 10) At the nearest cold treated water tap nearby remove the faucet screen, open the faucet and let water run a few minutes or until the system is free of any air or foreign material resulting from the plumbing work. Close the water tap when water runs clean, then proceed to start up instructions.

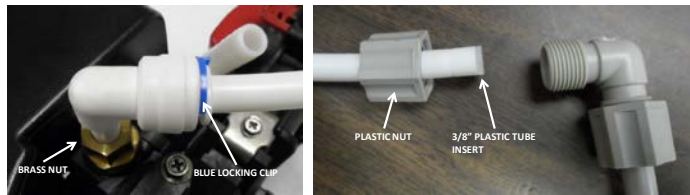

Figure 7. Brine Line Connections View

Start-Up Instructions

1. Plug the valve into an approved power source.
2. When power is supplied to the control, the screen will display "INITIALIZING WAIT PLEASE" while it finds the service position.
3. If screen is locked, press "□ MENU" for 3 seconds to unlock. Press "□ SET/REGEN" and hold for 3 seconds to initiate a manual regeneration and advance the valve to the Backwash position. Open the inlet on the bypass valve slowly and allow water to enter the unit. Allow all air to escape from the unit before turning the water on fully then allow water to run to drain for 3-4 minutes or until all media fines are washed out of the softener.
4. Press any button to advance to the BRINE position. Check the water level in the brine tank to insure the valve is drawing brine properly.
5. Press any button to advance to the RINSE position. Check the drain line flow. Allow the water to run for 3-4 minutes or until the water is clear.
6. Press any button to advance to the REFILL position. Check that the valve is filling water into the brine tank. Allow the valve to refill for the correct amount of time as displayed on the screen to insure a proper brine solution for the next regeneration.
7. Press any button to advance to the SERVICE position. Open the outlet valve on the bypass, then open the nearest treated water faucet and allow the water to run until clear, close the tap and replace the faucet screen.
8. Add salt into the brine tank.
9. Program hardness and people into controller using Level One Programming Instructions.

Level I User Programming

Setting Current Time

1. If screen is locked, press "□ MENU" for 3 seconds to unlock. Press "□ MENU" again to enter level one programming mode and adjust CURRENT TIME.
2. Press "□ SET/REGEN" to adjust hours. When you have entered the change value mode, the cursor will blink. Press "▲ or ▼ UP OR DOWN" arrows to change the hour values. Press "□ SET/REGEN" again to accept the hour value and advance to change the minutes value. Press "▲ or ▼ UP OR DOWN" arrows to change the minute values. Press "□ SET/REGEN" again to accept the minute values and advance to adjust the AM/PM values. Press "▲ or ▼ UP OR DOWN" to change the AM/PM value. Press "□ SET/REGEN" again to accept the AM/PM value and exit. When you have exited the change value mode, the cursor will stop flashing.

Setting Current Date

1. Press "▼ DOWN" to advance to CURRENT DATE.
2. Using the same procedure as setting the time, press "□ SET/REGEN" to enter value change mode.

Setting Number of People

1. Press "▼ DOWN" to advance to NUMBER OF PEOPLE.
2. Press the "□ SET/REGEN" to change the value. Press up or down arrows to change the values.

Setting Water Hardness

1. Press “▼ DOWN” to advance to WATER HARDNESS.
2. Press the “□ SET/REGEN” to change the value. Press “▲ or ▼ UP OR DOWN” to change the values.

Setting Vacation Mode

1. Press “▼ DOWN” to advance to VACATION MODE.
2. Press the “□ SET/REGEN” to change the value. Press “▲ or ▼ UP OR DOWN” to change the values.

Exiting Level One User Program Mode

At any time, press the “□ MENU” to accept all changes and return to main page display.

Level I User Program Mode		
PARAMETER	OPTIONS	DESCRIPTION
1	CURRENT TIME	This option is the current time of day.
2	CURRENT DATE	This option is the current date. The date is used to track the last time the system regenerated.
3	NUMBER PEOPLE	This value is the number of people living in the home. It is used to calculate the amount of water needed for daily use and the reserve capacity of the system.
4	WATER HARDNESS	This value is the maximum water hardness in grains per gallon of the raw water supply. It is used to calculate the system capacity.
5	VACATION MODE	This function may be activated by the user during a prolonged absence such as vacation. The system will perform a brief backwash and rinse based on the advanced setting. The purpose is to keep the water fresh in the softener tank and plumbing system.
	Yes	
	No	

Figure 8. Level I Program Options

Level I User Programming Flow Chart

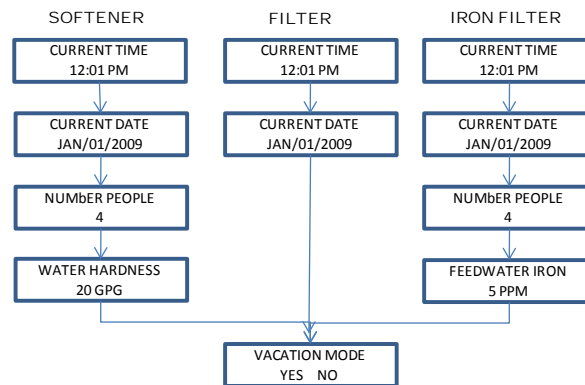





Figure 9. Level I User Program Flow Chart

Level II User Programming

When the Level Two Master Programming Mode is entered, all available option setting displays may be viewed and set as needed. Depending on current option settings, some parameters cannot be viewed or set.

1. If screen is locked, press “ MENU” for 3 seconds to unlock.
2. Press and hold “  UP AND DOWN” for three seconds to enter Level Two Master Programming.

Level II Master Program Mode			
PARAMETER	OPTIONS	DESCRIPTION	
1	SYSTEM LANGUAGE	ENGLISH	This option controls which language should be used in the valve display.
		FRENCH	
		SPANISH	
2	VALVE OPERATION	SOFTENER	There are three basic operating modes to choose depending on the system application.
		FILTER	
		IRON FILTER	
3	REGEN. MODE	METER DELAYED	This is the most common setting. When the volume remaining reaches zero gallons, the system will initiate a regeneration at the next pre-set regeneration time.
		METER IMMEDIATE	The unit will initiate a regeneration immediately after the volume remaining reaches zero.
		CALENDAR CLOCK	The unit will initiate a regeneration at the next pre-set regeneration time based on the interval of days between regeneration days.
		METER OVERRIDE	When the volume remaining reaches zero gallons, the system will initiate a regeneration at the next pre-set regeneration time. If the days between regeneration is reached before the remaining volume reaches zero, the system will override the meter setting and initiate a regeneration.
4	REGENERATION TIME	This setting controls the time of day when a regeneration cycle will start.	
5	CAPACITY CALC.	AUTOMATIC	This option automatically calculates the capacity (in gallons for meter units), refill time (in minutes), or regeneration day intervals (days for calendar clock mode).
		MANUAL	The user can manually enter values for capacity, refill time, or regeneration day intervals.
6	RESIN VOLUME	This value should be the amount of resin in cubic feet that is loaded in to the tank. The value is used to calculate the system capacity and refill time.	
7	SALT SETTING	This value is the salt dosage (pounds per cubic foot) to be used when regenerating the system.	
8	REFILL FLOW RATE	This value is the flow rate (gallons per minute) of the brine line flow control (BLFC) button installed in the valve and is used to calculate the refill time to precisely measure the amount of water into the brine tank. (Note: This value is factory preset and should not be changed unless the BLFC button has been changed to a different size.)	
9	UNIT CAPACITY	This value (GRAINS for softeners, PPM for IRON FILTERS) is the total capacity of the system. It is used to calculate the capacity of the system in gallons.	
10	CAPACITY		In MANUAL CAPACITY CALC. mode, the CAPACITY can be adjusted by the user. In AUTOMATIC CAPACITY CALC. mode, the current calculated value is displayed but cannot be adjusted.
		FORMULA	$CAPACITY = (UNIT\ CAPACITY / WATER\ HARDNESS) - (NUMBER\ PEOPLE * DAILY\ USAGE)$
11	DAILY USAGE	This value is the average amount of water used per person per day. It is used to calculate the REGEN. DAYS for calendar clocks.	
12	RESERVE CAPACITY	This value is the amount of water per person in gallons to be saved for a reserve capacity. It is used to calculate the CAPACITY of the system.	
13	REGEN. DAYS		This value is the interval (days) between regenerations. It is used to determine how many days between regenerations in the CALENDAR CLOCK mode. It is also used as the value for the METER OVERRIDE mode. It can be set by the user in MANUAL CALC. MODE. In AUTOMATIC CAPACITY CALC. mode, the current calculated value is displayed but cannot be adjusted.
		FORMULA	$REGEN.\ DAYS = ((UNIT\ CAPACITY / WATER\ HARDNESS) / (NUMBER\ PEOPLE * DAILY\ USAGE)) - 1$
14	BACKWASH	This option controls the length of time in minutes for the unit to clean the bed by reversing the flow of water upwards through the bed and out to the drain.	
15	BRINE / RINSE	This option controls the length if time in minutes for the unit to draw regenerant (brine for softeners) from the second tank and slowly rinse it from the top to bottom of the tank.	
16	RINSE	This option controls the length of time to give the tank a final rinse from the top to the bottom in order remove any last traces of the regenerant (brine) from the tank.	
17	REFILL		This option controls the length of time the brine valve will open to refill the second tank (brine tank for softeners) with water in order to produce the regenerate solution (brine for softeners) for the next regeneration cycle. The water is accurately measured through the valves brine line flow control to make a precise quantity of regenerant solution. In MANUAL CAPACITY CALC. mode, the REFILL time can be adjusted by the user. In AUTOMATIC CAPACITY CALC. mode, the current calculated value is displayed but cannot be adjusted.
		FORMULA	$REFILL = SALT\ SETTING * RESIN\ VOLUME / 3 / REFILL\ FLOW\ RATE$
18	RESTORE DEFAULT	YES	This option allows the current settings to be erased and changed back to the default settings.
		NO	

Figure 10. Level II Program Options

Level II User Programming Softener Flow Chart

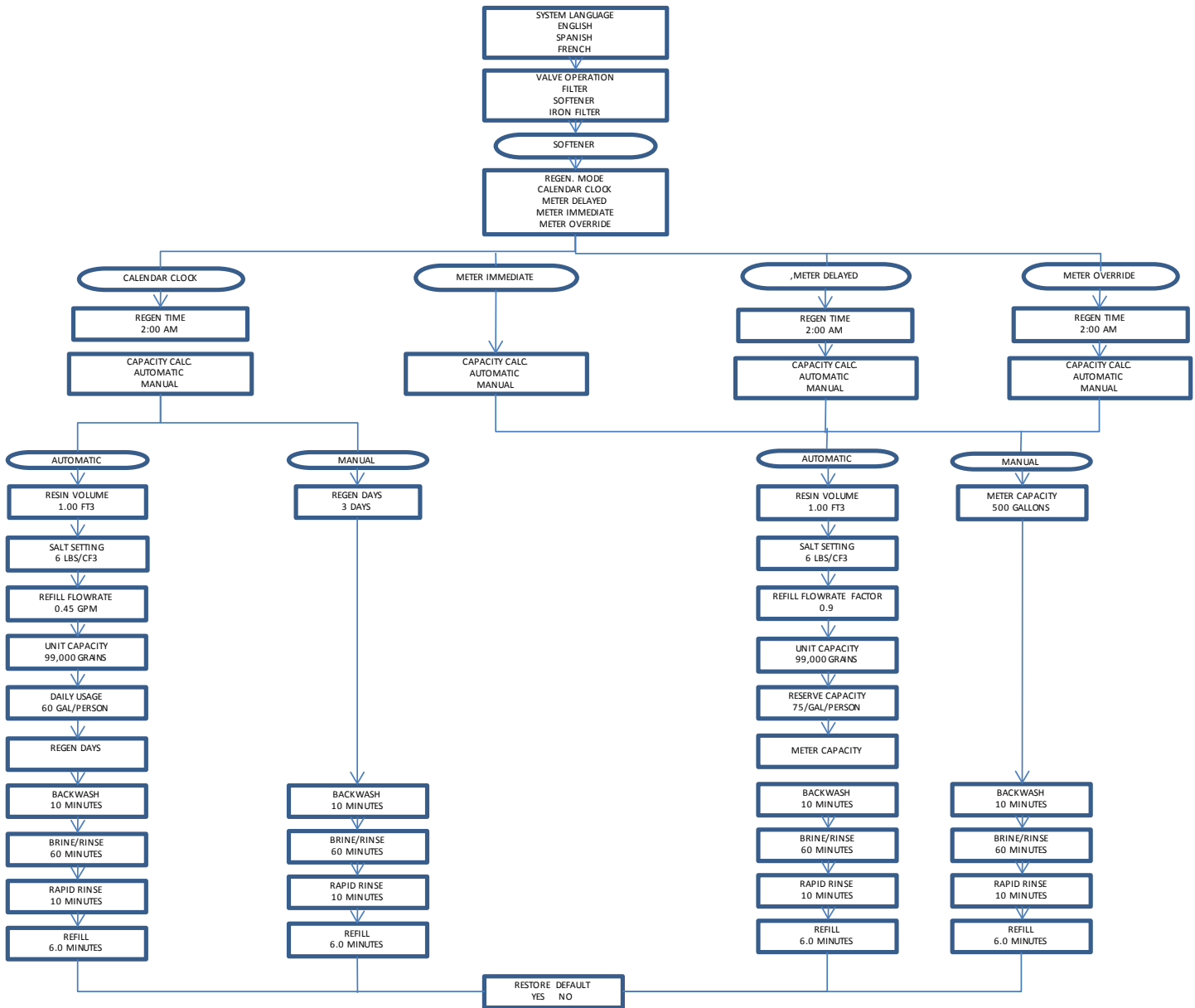





Figure 11. Level II User Program Flow Chart

Diagnostics Mode

1. If screen is locked, press “**□** MENU” for 3 seconds to unlock.
2. Press and hold the “**▼**” DOWN button for three seconds to enter Level Diagnostics Mode. In this mode, key diagnostics can be viewed for trouble shooting and problem solving. In addition, the values can be reset to zero individually by pressing “**□** SET/REGEN” for 3 seconds

Vacation Settings Mode

1. If screen is locked, press “ MENU” for 3 seconds to unlock.
2. Press “” to advance to VACATION MODE.
3. Press and hold the “ UP” for three seconds to enter the Vacation Settings Mode. In this mode the length of time for backwash and rinse along with the frequency are set while the valve is in vacation mode.

PARAMETER	DESCRIPTION
REGEN. DAYS	This value is the frequency of how often the unit should perform a brief backwash and rinse.
BACKWASH	This option controls the length of time in minutes for the unit to briefly clean the bed by reversing the flow of water upwards through the bed and out to the drain.
RINSE	This option controls the length of time to give the tank a brief rinse from the top to the bottom in order to remove any stale or stagnant water from the tank.

Figure 12. Vacation Mode Settings















System Configuration

Valve Set Up

RESIN VOLUME	VALVE CYCLE SETTINGS (MINUTES)					
	CLEAN WATER			PROBLEM WATER		
	BACKWASH	BRINE/RINSE	RINSE	BACKWASH	BRINE/RINSE	RINSE
0.75	5.0	50.0	5.0	10.0	60.0	10.0
1.00	5.0	50.0	5.0	10.0	60.0	10.0
1.50	5.0	50.0	5.0	10.0	60.0	10.0
2.00	5.0	50.0	5.0	10.0	60.0	10.0
2.50	5.0	50.0	5.0	10.0	60.0	10.0
3.00	5.0	50.0	5.0	10.0	60.0	10.0

Figure 13. Valve Set Up

Changing Valve Cycle Settings

1. If screen is locked, press “ MENU” for 3 seconds to unlock.
2. Press and hold “  UP AND DOWN” for three seconds to enter Level Two Master Programming.
3. Press the “ DOWN” and advance to the BACKWASH menu option. Press “ SET/REGEN” to edit the BACKWASH minutes. Press “ or  UP OR DOWN” arrows to change the BACKWASH minute values. Press “ SET/REGEN” again to accept the new value.
4. Press the “ DOWN” twice to advance to the RINSE menu option. Press “ SET/REGEN” to edit the RINSE minutes. Press “ or  UP OR DOWN” arrows to change the RINSE minute values. Press “ SET/REGEN” again to accept the new value.
5. Press “ MENU” to exit programming mode.

Automatic Bypass

The regeneration cycle lasts approximately 70 minutes, after which soft water service will be restored. During regeneration, hard water is automatically bypassed for use in the household. Hot water should be used as little as possible during this time to prevent hard water from filling the water heater. This is why automatic regeneration is set for sometime during the night and manual regenerations should be performed when little or no water will be used in the household.

Safety Float

The brine tank is equipped with a safety float which prevents your brine tank from overflowing as a result of a malfunction such as a power failure.

New Sounds

You may notice new sounds as your water softener operates. The regeneration cycle lasts approximately 2 hours. During this time, you may hear water running intermittently to the drain.

Manual Bypass

In the case of emergency, such as an overflowing brine tank, you can isolate your water softener from the water supply using the bypass valve located at the back of the control. In normal operation the bypass is open with the on/off knobs in line with the inlet and outlet pipes. To isolate the softener, simply rotate the knobs clockwise (as indicated by the word BYPASS and arrow) until they lock. You can use your water related fixtures and appliances as the water supply is bypassing the softener. However, the water you use will be hard. To resume soft water service, open bypass valve by rotating the knobs counterclockwise.

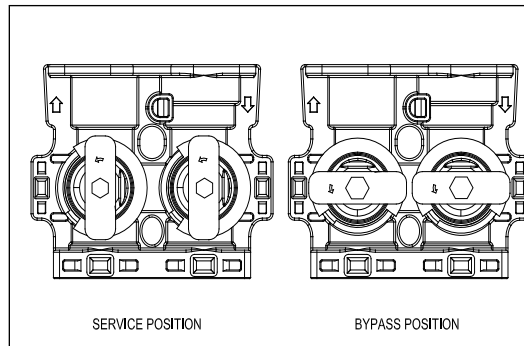

Figure 14. Bypass Installation View

Maintenance

Adding Salt

Use only crystal water softener salt. Check the salt level monthly. It is important to maintain the salt level above the water level. To add salt, simply lift the salt lid and add the salt directly into the brine tank. Be sure the brine well cover is on and fill only to the height of the brine well.

Bridging

Humidity or wrong type of salt may create a cavity between the water and the salt. This action, known as “bridging”, prevents the brine solution from being made, leading to your water supply being hard.

If you suspect salt bridging, carefully pound on the outside of the brine tank or pour some warm water over the salt to break up the bridge. This should always be followed up by allowing the unit to use up any remaining salt and then thoroughly cleaning out the brine tank. Allow four hours to produce a brine solution, then manually regenerate the softener.

Care of Your Softener

To retain the attractive appearance of your new water softener, clean occasionally with mild soap solution. Do not use abrasive cleaners, ammonia or solvents. Never subject your softener to freezing or to temperatures above 120°F.

Cleaning the Injector Assembly

Sediment, salt and silt will restrict or clog the injector. A clean water supply and pure salt will prevent this from happening.

The injector assembly is located on the right side of the control valve. This assembly is easy to clean.

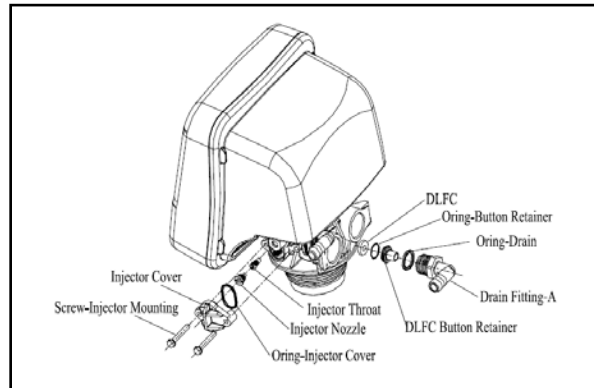

Figure 15. Injector Assembly View

Shut off the water supply to your softener and reduce the pressure by opening a cold soft water faucet. Using a screwdriver, remove the two screws holding the injector cover to the control valve body. Carefully remove the assembly and disassemble as shown in Figure 6. The injector orifice is removed from the valve body by carefully turning it out with a large screwdriver. Remove the injector throat the same way. Carefully flush all parts including the screen. Use a mild acid such as vinegar or Pro-Rust Out to clean the small holes in the orifice and throat.

Reassemble using the reverse procedure.

Resin Cleaner

An approved resin cleaner **must** be used on a regular basis if your water supply contains iron. The amount of resin cleaner and frequency of use is determined by the quantity of iron in your water (consult your local representative or follow the directions on the resin package).

Sanitizing Procedure

Care is taken at the factory to keep your water softener clean and sanitary. Materials used to make the softener will not infect or contaminate your water supply, and will not cause bacteria to form or grow. However, during shipping, storage, installing and operating, bacteria could get into the softener. For this reason, sanitizing as follows is suggested when installing.

Sani-System Liquid Sanitizer Concentrate



Item# 80030021—Softener Sanitizer 0.25 fl.oz (24 Pack)

1. Be sure to complete all installation steps, including programming.
2. For effective and complete sanitization, EcoSmart recommends Sani-System Liquid Sanitizer Concentrate. Pour one 0.25 fl. Oz. package into the brine well located in the cabinet tank. (Alternative use 3/4 oz of common 5.25% household bleach)
3. Start an immediate regeneration. If screen is locked, press MENU for 3 seconds to unlock. To initiate an Immediate Regeneration, press the SET / REGEN button for 3 seconds, an option for Delayed or Immediate Regeneration will appear. Press the SET / REGEN button again and delayed will begin flashing, press the down arrow button to have Immediate flash, press the SET / REGEN button and then press the MENU button and the valve will immediately start into manual regeneration.
4. The Softener Sanitizer Solution is drawn into and through the water softener to sanitize it. This sanitizing regeneration is over in about two hours. Then, soft water is available for your use.

NOTE: Sanitizing is recommended by the Water Quality Association for disinfecting. On some water supplies, they suggest periodic sanitizing.

Valve Drive Assembly Exploded View

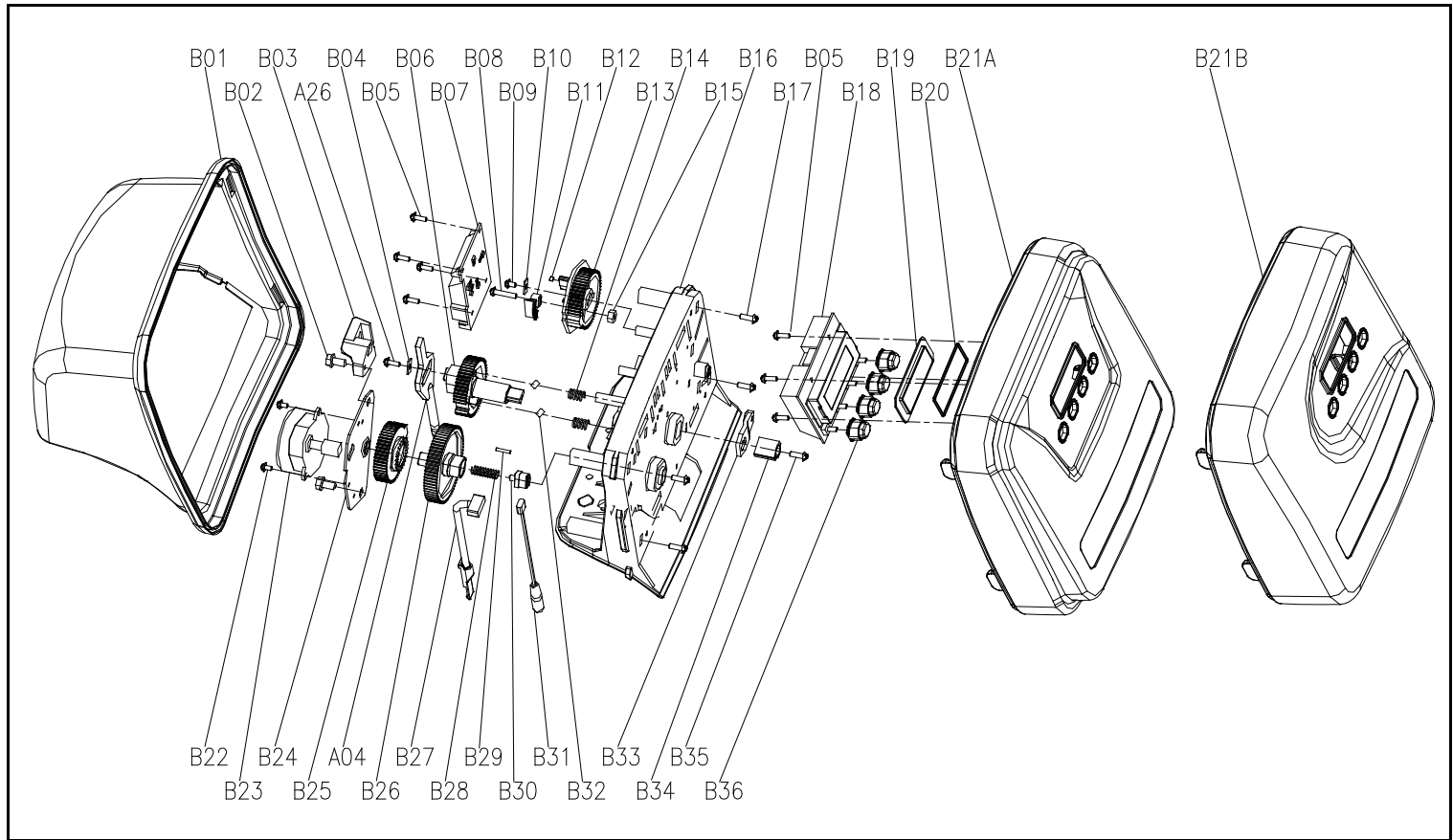

Item No.	Part No.	Part Description	Quantity	Item No.	Part No.	Part Description	Quantity
B01	05056523	Bnt365 Cover	1	B21A	05056527	Bnt465 Front Cover	1
B02	05056136	Screw-ST3.5x13(Hexagon with Washer)	2	B21B	05056531	Bnt665 Front Cover	1
B03	05010045	Piston Stem Holder	1	B22	05056082	Screw-M3x6	2
A26	13000426	Screw-ST2.9x13(Large Washer)	1	B23	05056510	Motor-12v/2rpm	1
B04	05056139	Washer-3x13	1		05030014	Motor Power Cable	1
B05	05010037	Screw-ST2.9x10	8		11700005	Wire Connector	2
B06	05056005	Main Gear	1	B24	05056045	Motor Mounting Plate	1
B07	05030010	Bnt85 Main Pcb	1	B25	05056501	Drive Gear	1
B08	05056083	Screw-M4x14	1	A04	05010081	Bnt65 Piston Rod	1
B09	05056166	Screw-ST4.2x12(Large Washer)	1	B26	05056002	Helix Gear	1
B10	05056141	Washer-4x12	1	B27	05010031	Meter Assembly	1
B11	05056016	Brine Regulator	1		05010046	Meter Stand Relief	1
B12	05010023	Magnet-48x2.7	1	B28	05056094	Spring Hler	1
B13	05056015	Brine Gear	1	B29	05056098	Motor Pin	1
B14	05056095	Spring Detent	2	B30	05056502	Spring Retainer	1
B15	05056089	Nut-M4	1	B31	05010029	Power Cable	1
B16	05056522	Bnt365 Housing	1		05056013	Power Stand Relief	1
B17	05056084	Screw-ST3.5x13	4	B32	05056092	Ball-1/4inch	2
B18	05030020	Bnt85 Display(NOV0)	1	B33	05056503	Magnet Holder	1
	05056536	Bnt465 Wiring Harness	1	B34	05056554	Locking Knob	1
B19	05056528	Pcb Cover	1	B35	05056561	Screw-ST3.5x15(CSK)	1
B20	26010047	O-Ring-40x1.8	1	B36	05056529	Bnt465 Button	4

To order replacement parts contact your dealer. For help in locating your dealer please call 1-877-444-3348.

Control Valve Exploded View

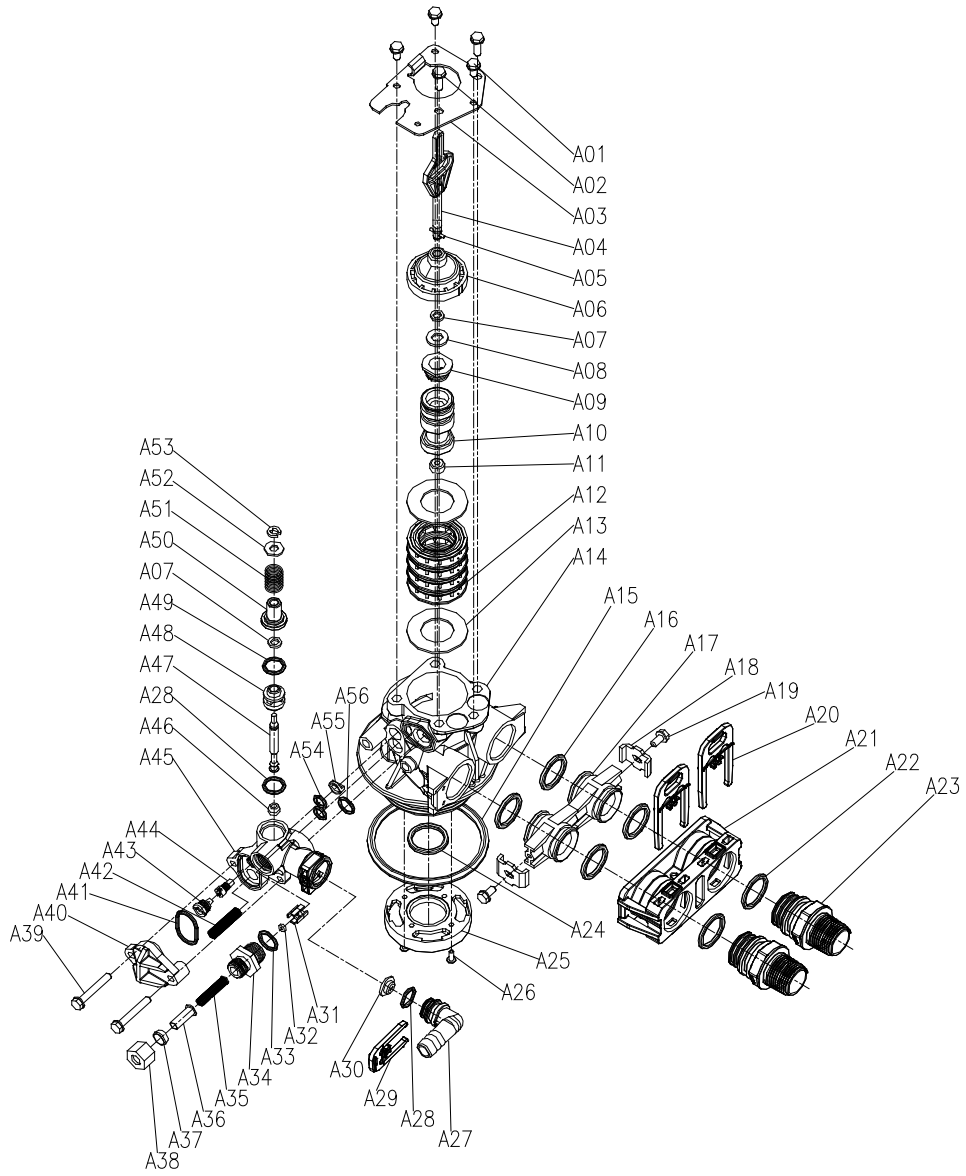

See parts listing on next page (16)

Control Valve Parts List

Item No.	Part No.	Part Discription	Quantity
A01	05056087	Screw-M5×12(Hexagon)	3
A02	05056088	Screw-M5×16(Hexagon with Washer)	2
A03	05056047	End Plug Retainer	1
A04	05010081	Bnt65 Piston Rod	1
A05	05056097	Piston Pin	1
A06	05056023	End Plug	1
A07	05056070	Quad Ring	2
A08	05056024	End Plug Washer	1
A09	05056022	Piston Retainer	1
A10	05056181	Piston (Electrical)	1
A11	05056104	Muffler	1
A12	05056021	Spacer	4
A13	05056073	Seal	5
A14	05056019	Bnt65 Valve Body	1
A15	05056063	O-ring- ϕ 78.74×5.33	1
A16	05056129	O-ring- ϕ 23×3	4
A17	05056025	Adaptor Coupling	2
A18	05056044	Adaptor Clip	2
A19	05056090	Screw-ST4.2×13(Hexagon with Washer)	2
A20	21709003	Secure Clip	2
A21	05056140	Valve Connector	1
A22	05056065	O-ring- ϕ 23.6×2.65	2
A23	21319006	Screw Adaptor	2
A24	26010103	O-ring- ϕ 25×3.55	1
A25	07060007	Valve Bottom Connector	1
A26	13000426	Screw-ST2.9×13(Large Wafer)	2
A27	05010082	Drain Fitting	1
A28	05056134	O-Ring- ϕ 12×2	1
A29	05056172	Secure Clip-S	1
A30	05056186	DLFC-2#	1
A32	05056035	BLFC Button Retainer	1
A33	05056191	BLFC-2#	1
A34	05056138	O-Ring- ϕ 14×1.8	1
A35	05056100B	BLFC Fitting	1
A36	05056106	Brine Line Screen	1
A37	05056107	BLFC Tube Insert	1
A38	05056033	BLFC Ferrule	1
A39	05056108	BLFC Fitting Nut	1
A40	05056086	Screw-M5×30(Hexagon with Washer)	2
A41	05056029	Injector Cover	1
A42	05056072	O-Ring- ϕ 24×2	1
A43	05056103	Injector Screen	1
A44	05056027	Injector Nozzle	1
A45	05056028	Injctor Throat	1
A46	05056177	Injector Body	1
A47	05056075	Injector Seat	1
A48	05056134	O-Ring- ϕ 12×2	1
A49	05056054	Injector Stem	1
A50	05056031	Injector Spacer	1
A51	05056081	O-Ring- ϕ 12.5×1.8	1
A52	05056030	Injector Cap	1
A53	05056093	Injector Screen	1
A54	05010049	Special Washer	1
A55	05056105	Retaining Ring	1
A56	05056067	O-Ring- ϕ 7.8×1.9)	2
A57	05056037	Air Disperser	1
A58	05056066	O-Ring- ϕ 11×2	1

Trouble Shooting

Issue	Possible Cause	Possible Solution
A. Unit fails to initiate a regeneration cycle.	1. No power supply.	Check electrical service, fuse, etc.
	2. Defective circuit board.	Replace faulty parts.
	3. Power failure.	Reset time of day.
B. Water is hard.	1. By-pass valve open.	Close by-pass valve.
	2. Out of salt.	Add salt to tank.
	3. Plugged injector / screen.	Clean parts.
	4. Flow of water blocked to brine tank.	Check brine tank refill rate.
	5. Hard water in hot water tank.	Repeat flushing of hot water tank required.
	6. Leak between valve and central tube.	Check if central tube is cracked or o-ring is damaged. Replace faulty parts.
	7. Internal valve leak.	Replace valve seals, spacer, and piston assembly.
C. Salt use is high.	1. Refill time is too high.	Check refill time setting.
D. Low water pressure.	1. Iron or scale build up in line feeding unit.	Clean pipes.
	2. Iron build up inside valve or tank.	Clean control and add resin cleaner to clean bed. Increase regeneration frequency.
	3. Inlet of control plugged due to foreign material.	Remove piston and clean control valve.
E. Resin in drain line.	1. Air in water system.	Check well system for proper air eliminator control.
	2. Incorrect drain line flow control (DLFC) button.	Check for proper flow rate.
F. Too much water in brine tank.	1. Plugged injector or screen.	Clean parts.
	2. Valve not regenerating.	Replace circuit board, motor, or control.
	3. Foreign material in brine valve.	Clean parts.
G. Unit fails to draw brine.	1. Drain line flow control is plugged.	Clean parts.
	2. Injector or screen is plugged.	Clean parts.
	3. Inlet pressure too low.	Increase pressure to 25 PSI.
	4. Internal valve leak.	Replace seals, spacers, and piston assembly.
H. Valve continuously cycles.	1. Defective position sensor PCB.	Replace faulty parts.
I. Flow to drain continuously.	1. Valve settings incorrect.	Check valve settings.
	2. Foreign material in control valve.	Clean control.
	3. Internal leak.	Replace seals, spacers, and piston assembly.

Manufacturers Warranty

Canature Watergroup warrants that your new water conditioner is built of quality material and workmanship. When properly installed and maintained, it will give years of trouble free service.

Seven Year Complete Parts Guarantee

Canature WaterGorup will replace any part which fails within 84 months from date of manufacture, as indicated by the serial number, provided the failure is due to a defect in material or workmanship. The only exception shall be when proof of purchase or installation is provided and then the warranty period shall be from the date thereof.

Life Time Guarantee on Mineral Tanks and Brine Tanks

Canature WaterGroup will provide a replacement mineral tank or brine tank to any original equipment purchaser in possession of a tank that fails provided that the water conditioner is at all times operated in accordance with specifications and not subject to freezing.

General Provisions

Damage to any part of this water conditioner or filter as a result of misuse, misapplication, neglect, alteration, accident, installation or operation contrary to our printed instructions, damage to ion exchange resin and seals caused by chlorine / chloramines in the water supply, or damage caused by any force of nature is not covered in this warranty. We will repair or replace defective parts if our warranty department determines it to be defective under the terms of this warranty. Canature assumes no responsibility for consequential damage, la-bour or expense incurred as a result of a defect or failure.